

WK
.M78
.2



CHIP CARVING

HARRIS W. MOORE

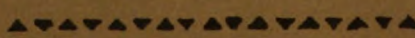

PUBLISHED BY
THE MANUAL ARTS PRESS
PEORIA  ILLINOIS



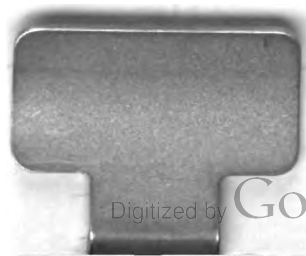

CHIP CARVING

By

HARRIS W. MOORE

*Supervisor of Manual Training
Watertown, Massachusetts*



THE MANUAL ARTS PRESS
PEORIA, ILLINOIS

Copyright, 1922
HARRIS W. MOORE

Printed in United States of America

267128
JUN 21 1928

WK
.M78
.2

CONTENTS

	PAGE
INTRODUCTION	5
TOOLS AND GENERAL DIRECTIONS	7
EASELS, TWO, PHOTOGRAPH OR POSTCARD	10
TOOTHPICK HOLDER, THREE PATTERNS	12
GLOVE BOX	12
CHECKER BOARD	16
PIN TRAY	18
STAMP BOX.	20
CARD CASE.	22
BLOTTER	24
PEG MORREL (GAME BOARD)	26
FOX AND GEESE (GAME BOARD)	28
THERMOMETER MOUNTS, TWO PATTERNS	30
PIPE RACK	32
HANDKERCHIEF BOX.	32
WHISKBROOM HOLDER	36
PICTURE FRAME.	38
PHOTOGRAPH FRAME.	40
WHISKBROOM HOLDER	42
WASTE BASKET	42
PAPER KNIVES, THREE	46

EXAMPLES OF PRIMITIVE CARVING.

The photographs on the two following pages show specimens of chip carving now located in the Peabody Museum, Harvard University.

No. 1 is a ceremonial adz from Mangaia Island in the Hervey Group in the South Pacific. It is about a yard long. The lower part of the handle is hollow and perforated, the remainder deeply incised.

No. 2 is a ceremonial or tribute paddle from Vavitao Island in the Australian Group. A lens will help to bring out the beauty of its carving. Notice that bands emphasize the center and outline of the paddle and that the junction of the shaft and blade is seemingly strengthened by horizontal rows of incisions as tho bound with cords. The blade is not flat but curved both transversely and longitudinally.

In No. 3 notice the beauty of the marvelous repetition, yet here also are the bands denoting structure.

No. 6 is from Mangaia Island and shows beautiful workmanship thruout. The jade head is bound to the handle with braided cord in an elaborate and skillful manner. This handle, like several others not shown, stands as erect as a column, whether from design or not, is not known. This handle suggested the pattern used in Plate XVI.

No. 7 from New Zealand is a storage box for feathers and other personal ornaments, used on special occasions. It is of rich brown wood with dull red paint in the incisions between the bands. What beautiful flowing curves they make! And there is the semblance of a chain to hold the treasures.

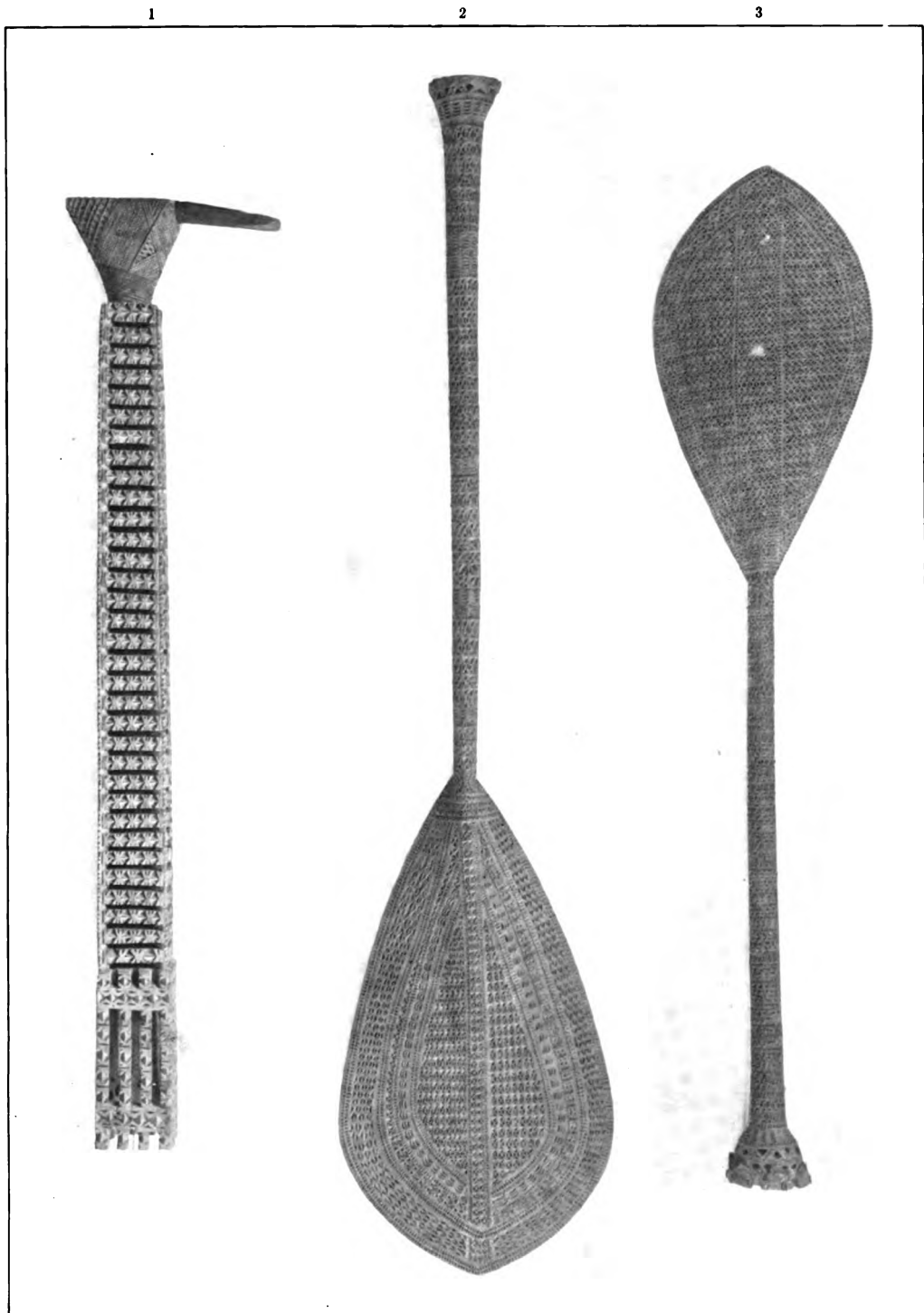

Photo by Marshall Studio, Cambridge, Mass

Peabody Museum, Harvard University

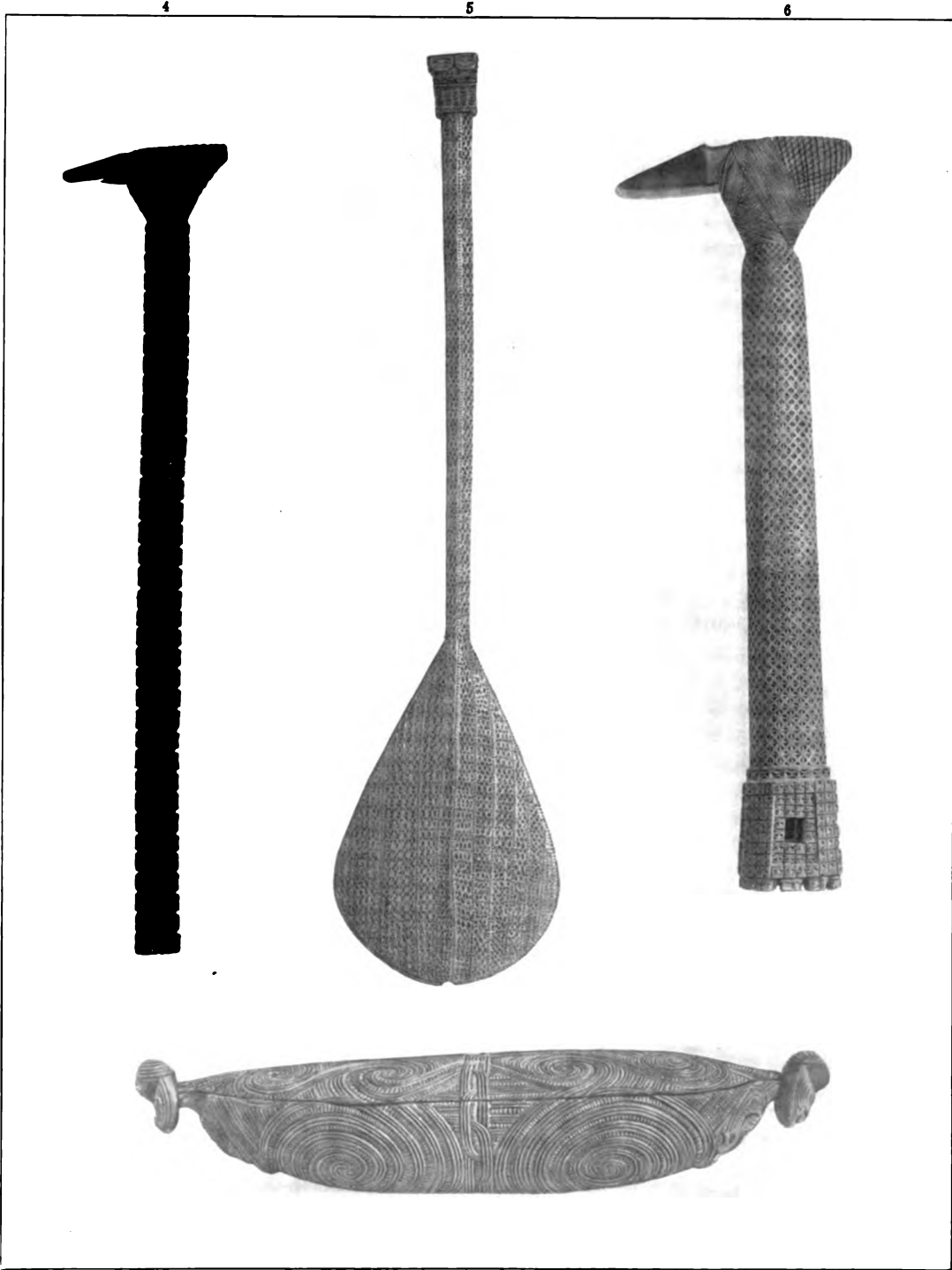

Photo by Marshall Studio, Cambridge, Mass.

Peabody Museum, Harvard University

INTRODUCTION



HIP-CARVING, characterized as it is by angular incisions in the surface decorated, occupies a very limited field in the realm of wood-carving. But with its limitations frankly recognized, it may appropriately be employed to enrich an otherwise plain surface. Because of its angularity, care must be exercised in applying it to curved surfaces or to surfaces having curved outlines, lest it become as degenerate as so many of our designs in cut glass have. Decoration by means of incisions has been utilized by many primitive peoples, because it is applied to an other-

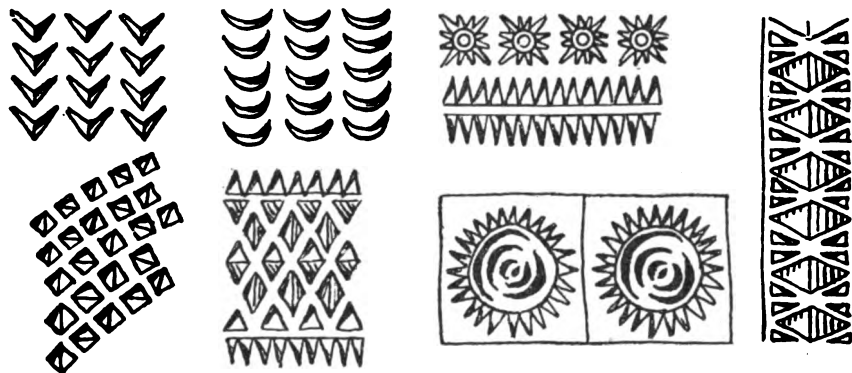

Fig. 1. Full-size units of primitive designs

wise finished surface. While handling his weapons and implements in times of leisure, the primitive man would naturally turn to scratches and incisions as a method of embellishment. To appreciate what chip-carving may be at its best, one should see some of the ceremonial adz handles and paddles produced by the primitive men of the South Pacific islands. The decoration of these articles is characterized by an all-over pattern of small units, for the most part deeply cut. Often these units are as small as $\frac{1}{8}$ " or $\frac{3}{16}$ ". The chief element in their beauty is repetition, and to achieve such beauty one must exercise great patience. As these articles were decorated for ceremonial occasion and not for daily use, no adaptations for convenience were necessary; some of the adz handles, for example, were hollow square tubes even as large as six inches on a side. Sharp corners and deep incisions were freely used. When we remember that these primitive craftsmen used a bit of shell or a shark's tooth as a cutting tool, we can appreciate better their devotion to their art. And let us always remember that without that devotion no beautiful thing is ever created.

Fig. 1 shows some full-size units of primitive design. Whatever motif was chosen it was used consistently, so that the whole decoration displayed unity. Lines of division were sometimes scratched and sometimes indicated by rows of very fine chips.

The photographs shown in the book should be studied closely by the beginner before undertaking to carve any of the articles drawn in this book. Close observation of these photographs will give a fair idea of how to execute a pattern which may seem obscure in the ink drawing.

TOOLS AND GENERAL DIRECTIONS

THO all the designs suggested in this book can be cut with the chip-carving knife shown in Fig. 2, the following additional tools will be found convenient: a wood-carver's veining tool, Fig. 3; a parting-tool $1/32''$ to $1/16''$ wide, Fig. 4; and a 1" skew chisel, Fig. 5, for the larger chips. In flower form rosettes, as in Plate XVII, a carver's gouge of proper curve shown in Fig. 6 is helpful for stabbing. These cutting tools should be honed to a keen, perfect edge on a fine sharpening stone, stropped on leather, and then protected from all injury by sticking them into corks when not in use. Results can be attained with perfect cutting tools which are simply unattainable with dull ones. For the single purpose of veining (cutting narrow grooves), the veining tool should be sharpened so that the cutting edges of the V slant forward somewhat so that



Fig. 2.
Knife

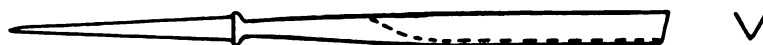

Fig. 3. Veining-tool

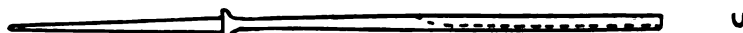

Fig. 4. Parting-tool



Fig. 5. Skew chisel



Fig. 6. Carver's gouge

they cut the wood just ahead of the point of the V as shown in Fig. 3. Only in this shape will this tool cut smoothly across the grain.

Since the designs in this book are all full size, it is expected that they will be traced and transferred to the model by carbon paper. Should they not be traced, the following drawing tools will be needed: T-square, 45° triangle, $30^\circ \times 60^\circ$ triangle, $22\frac{1}{2}^\circ \times 67\frac{1}{2}^\circ$ triangle, compass, divider, scroll, and ruler. Angles of 15° and 75° can be obtained by adding the 30° angle to the 45° triangle.

After one has acquired considerable skill in carving, not all the lines shown in the design need be drawn, for some of them will result from stabbing and some from cutting the chips. In general the important point to lay out is the point where the knife is set to stab the design.

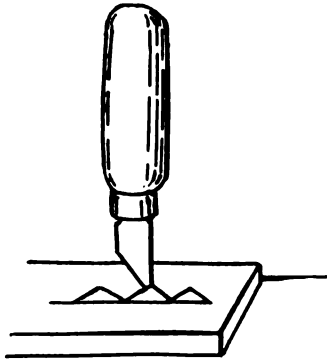

Fig. 7. Stabbing

The first cutting operation is to stab the design, making a vertical cut, the point of the knife being at the deepest part of the incision to be made, Fig. 7. Care must be taken to hold the knife vertical and make the stab coincide with the lines of the pattern. To remove the chip, the knife is held as in Fig. 8 with the thumb

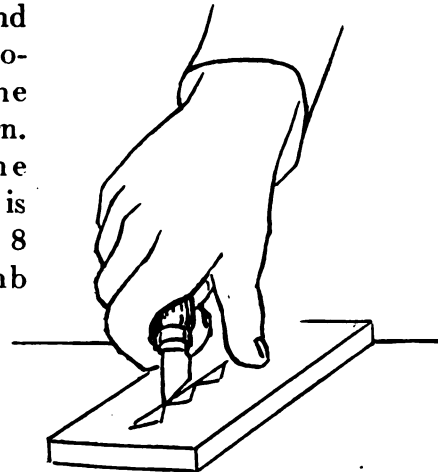

Fig. 8. Removing chips

held firmly on the work to serve as a sort of pivot on which to swing the hand while forcing the blade of the knife under the chip. In doing this the point of the knife must be kept from going into the vertical wall made by the stab, or into an adjoining chip. Small chips in straight grain wood should be removed at one cut; large ones, curved ones, or those in crooked grain may require two or more cuts to remove the chip smoothly. A smooth, crisp, clear-cut chip is the only one which should give satisfaction; but one should not give up if this is not obtained with the first trial, for sometimes unsuccessful cuts can be improved by recutting deeper.

In these plates dimensions are always given in the following order: length, width, thickness. The sign for inches is omitted because no model is large enough to require measurement by feet.

Two parallel lines close together (about $1/32$) represent a groove. Grooves may be cut with knife, parting tool, or veiner. In the attempt to indicate the valleys, (the deep incisions), by shading, the light is supposed to come from the upper left corner of the page. Before stabbing any pattern, one must have clearly in mind what chips are to be cut out.

Sparklets (little V-shape cuts in the edge of a chip as shown in plate XIII) are best cut with the knife held nearly vertical.

To add crispness to the carved pattern, it is sometimes necessary to stab it all again and thus clearly emphasize the deep places, the divisions between cuts.

In the selection of wood for the various articles illustrated in this book, the following considerations are pertinent. The soft, close-grain woods cut easier than the hard woods, but if subjected to hard usage they do not wear as well. For an article which is used rather intimately and viewed close by, a choice wood is appropriate. Some of the soft woods are pine, basswood, poplar or whitewood, and red-gun; those of medium hardness, mahogany and black walnut; the hard woods, cherry, oak, birch and hard maple. Of course, some trees of any of these kinds vary one way or the other from the average of its kind. Tho carved wood may be stained or dyed it is generally better to select wood of natural beauty, and to finish it without stain. Color, however, is such an important element of beauty and harmony that one should not hesitate to use the excellent commercial wood stains and dyes which are now available, if thereby the article is made more harmonious with its surroundings.

Before wood is finished it should be smooth and clean. No attempt should be made to sandpaper the actual cuts of a piece of chip carving. The tools should be sharp enough and used with such precision as to leave the surface smooth. If a surface needs sandpapering after it has been carved, the sandpapering should be done carefully with fine sandpaper wrapped snugly about a smooth flat block; and this should be moved in the direction of the grain. Great care is needed not to flatten the sharp ridges of the carving.

For articles which are not to be handled much, a wax or linseed oil finish is suitable. Dull rather than glossy finish should be used. An article that is apt to become soiled with handling and hence need cleaning at times is better finished with shellac or varnish. Thin white shellac laid on quickly with a soft camel's hair brush makes a good, hard finish. Shellac is not waterproof but turns white in a few hours under water.

A wax finish is easily obtained with the commercial prepared waxes or with beeswax cut with turpentine till a soft paste results. These waxes may be brushed on and then polished after a little time with a brush as shoes are polished. A good durable finish may be obtained in the course of several weeks by the use of linseed oil alone if successive applications of oil are rubbed well with a cloth and allowed to dry thoroly between applications. Sometimes a week is not too long a time to allow the oil to harden.

EASEL PLATE I.**FOR HOLDING PHOTOGRAPH OR POST CARD**

A. The grain of the wood in this easel should run vertically as the drawing is shown in this plate. One should not attempt to carve any pattern until one has succeeded in carving the design on a practice piece of wood. The model may or may not be planed thin at the wide end.

B. The heavy line indicating the valley and the miter lines at the corners are the important lines in the lay-out of this design. The carving of this pattern should start at the inner end of the fret, care being taken not to cut across any ridge. The sectional drawing shows ridges and valleys.

EASELS

A $3\frac{1}{4} \times 4 \times \frac{1}{2}$

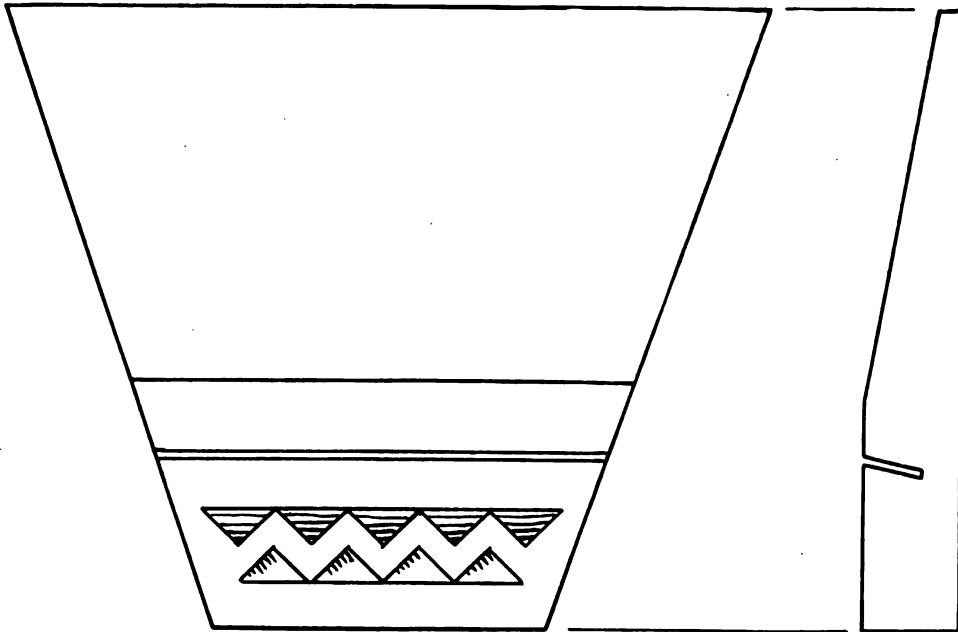

B $4\frac{1}{4} \times 2\frac{1}{2} \times \frac{3}{4}$

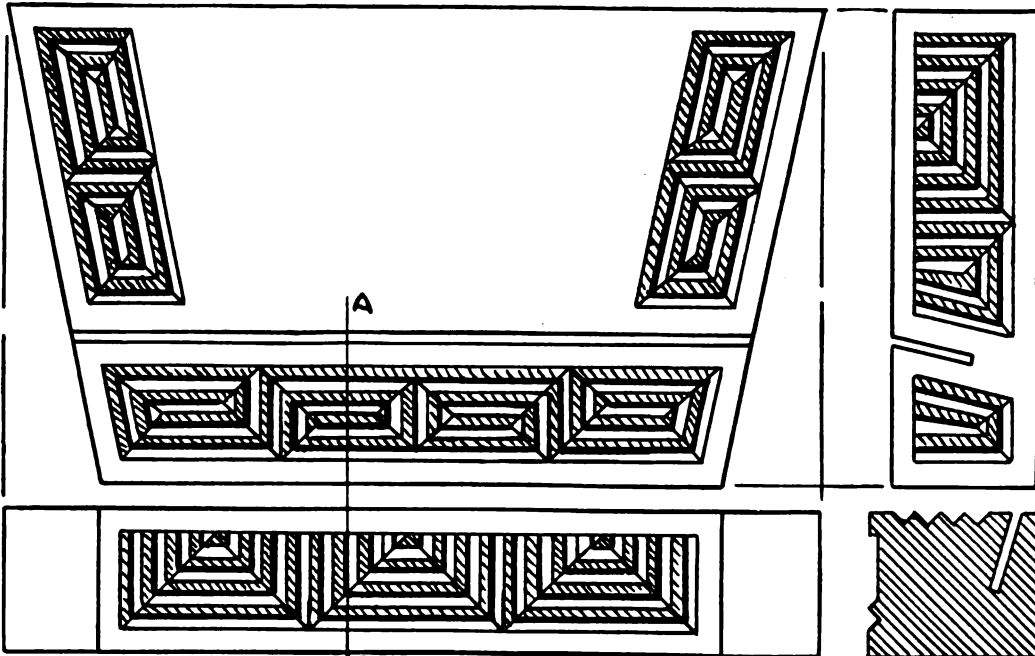

SECTION A B

PLATE I

TOOTHPICK HOLDER. PLATE II

A. This pattern is a primitive design from the South Pacific Islands.

B. Particular care should be taken to cut the grooves of uniform width. The crosses in the background are merely lines stabbed four times with the point of the knife at the intersection of the cross. In making any carving having radiating chips as in this pattern, which is an adaptation of the Greek honeysuckle, care must be taken to make the center of radiation as perfect as possible.

C. Sparklets may be added to the shallow chips to suggest a plant form.

GLOVE BOX. PLATE III

The carving on this box represents an interesting variation of grooving. The outer line of the pattern represents a vertical wall about $3/32$ deep, and should be cut first with the knife held vertically. The chip is cut slanting from the line next the outer line to this vertical wall. Only one-half of the front and top patterns is shown. The front and end shown in the drawing are the parts below the cover. If a lock is added to this box the front pattern should be modified to recognize the keyhole. A box like this should be glued and bradded together completely and then the cover sawed apart along the line of separation; $3/16$ is allowed for this.

TOOTHPICK HOLDER

OR MATCHES OR HAIRPINS.

BOTTOM $2 \times 2 \times \frac{3}{16}$
SIDES $2 \times 1\frac{1}{2} \times "$
ENDS $2 \times 1\frac{1}{8} \times "$

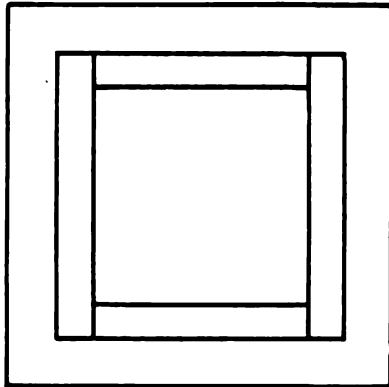

Repeat A, B, or C
on each side.

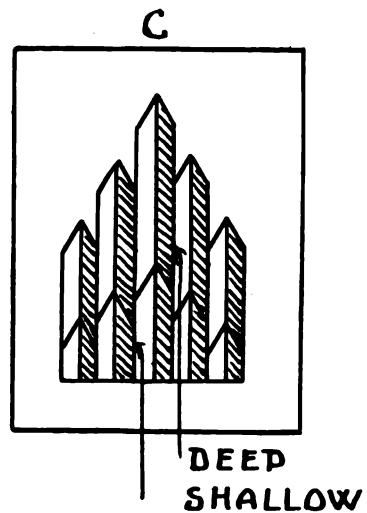
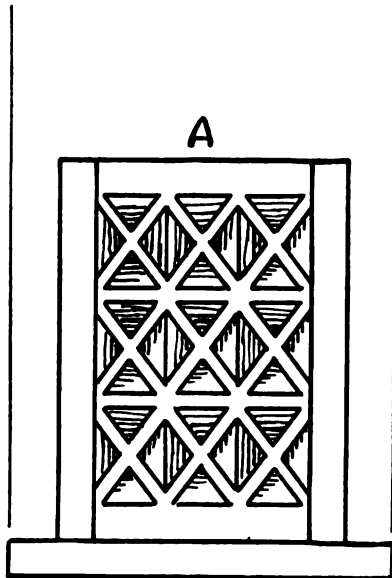

GLOVE BOX FRONT

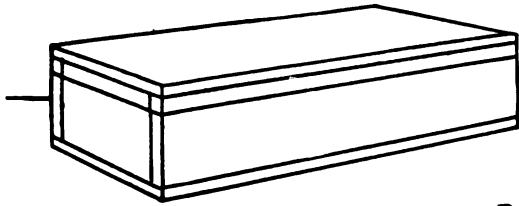

TOP $13\frac{3}{4} \times 5\frac{1}{4} \times \frac{3}{8}$
 FRONT " $\times 3\frac{11}{16} \times "$
 END $4\frac{1}{2} \times " \times "$
 $\frac{3}{16}$ is allowed for
 sawing apart the
 box to form cover.

END

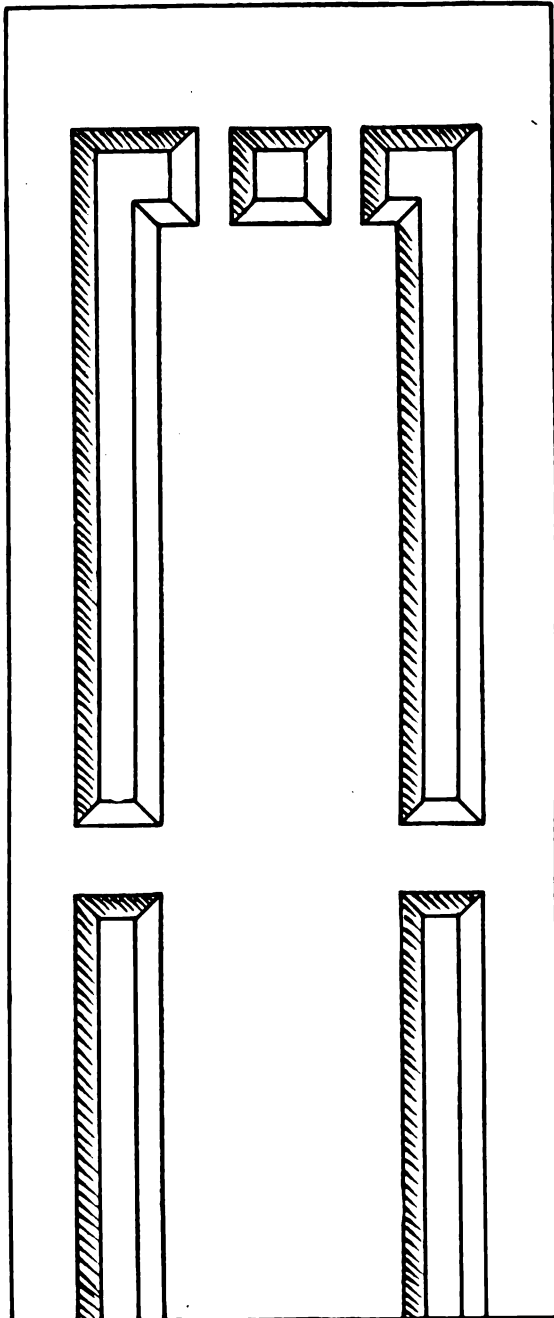
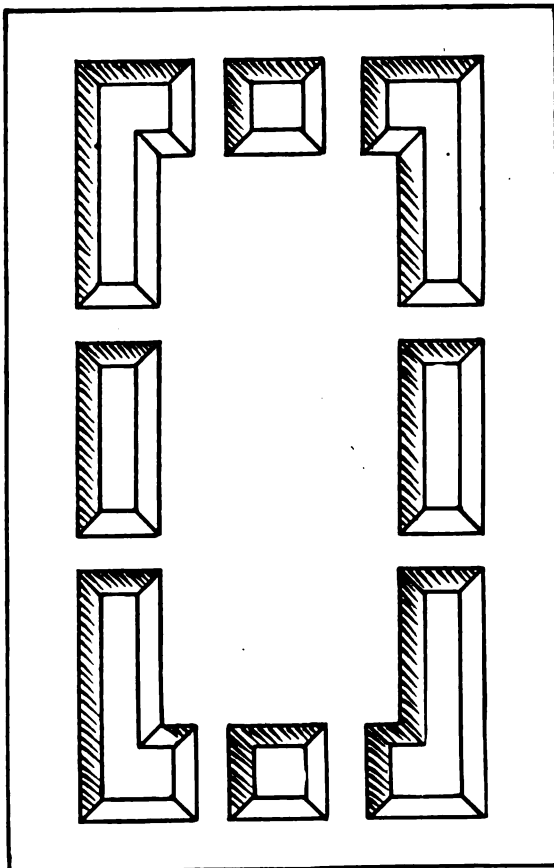

TOP OF GLOVE BOX .

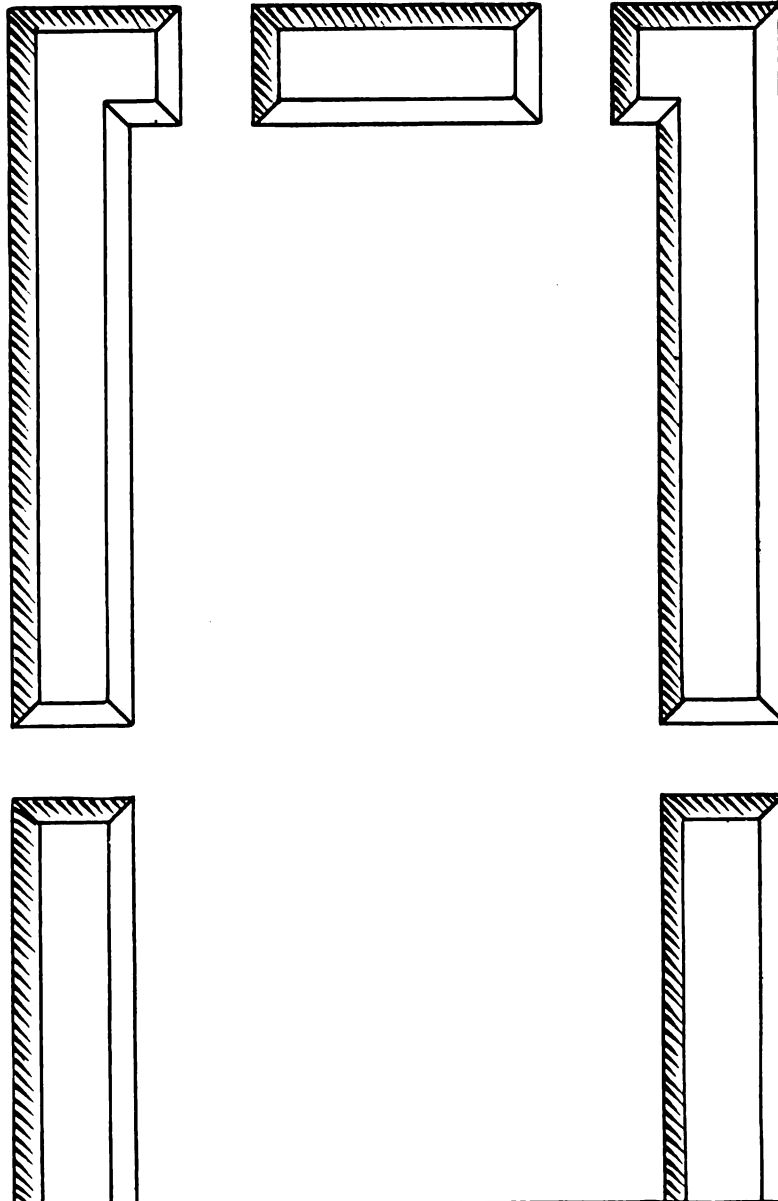

PLATE III-A

CHECKERBOARD. PLATE IV

This form of carving, sometimes called ribbon carving, permits the easy sliding of the checkers. It differs from that in Plate III in that the chip slants from the outer line to the next outer as shown in Section A. When selecting the wood for this checkboard, avoid any wood that is liable to warp. Well-seasoned mahogany is recommended.

CHECKER BOARD

11 × 11 × $\frac{7}{8}$

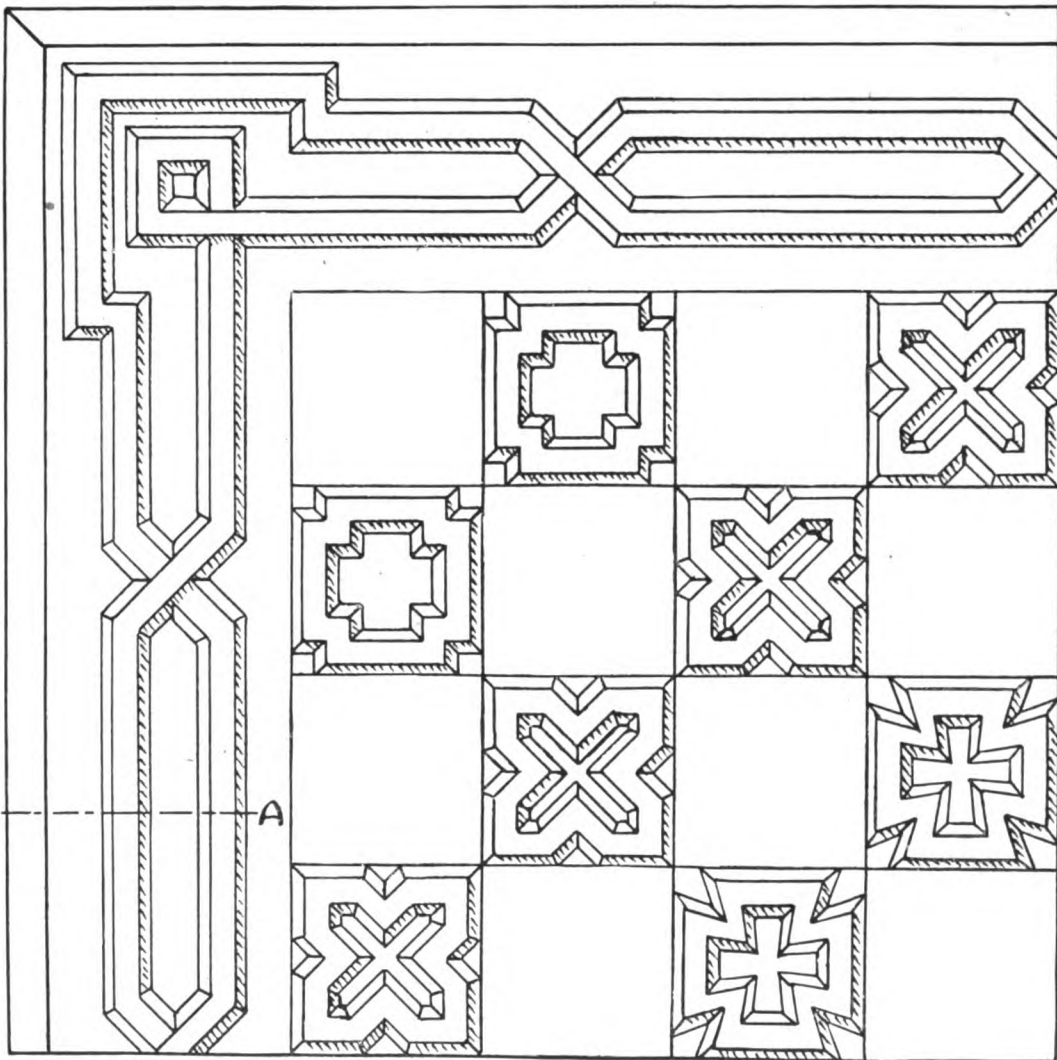

Designs may be repeated differently.

PIN TRAY. PLATE V

The diamond rosette should be cut rather shallow. Tho it may not look so, the all-over pattern is in this design laid out on the equilateral triangle, one side being $\frac{1}{4}$, and vertical. There are many other interesting modes of cutting on such a lay-out. This form was chosen to keep the surface as level as possible.

PIN TRAY

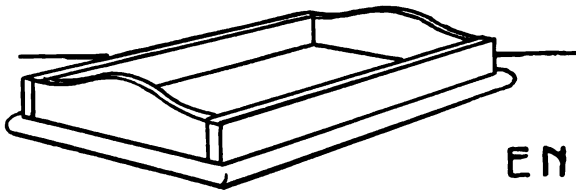

END

BOTTOM $5\frac{3}{4} \times 4 \times \frac{3}{16}$
 SIDE $5\frac{1}{2} \times \frac{1}{2} \times "$
 END $3\frac{3}{8} \times \frac{3}{4} \times "$

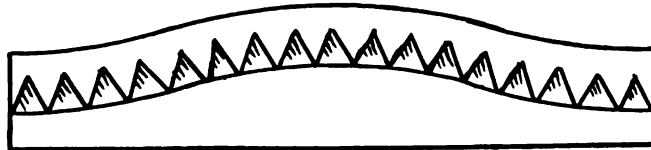

SIDE



BOTTOM

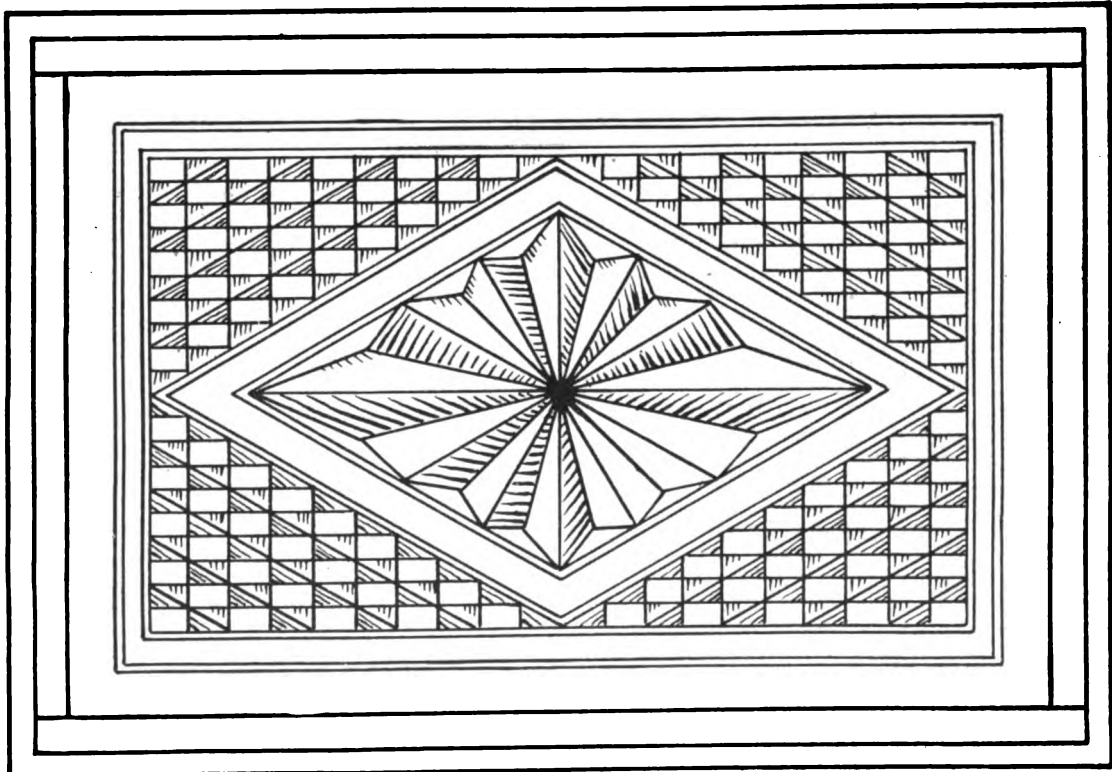
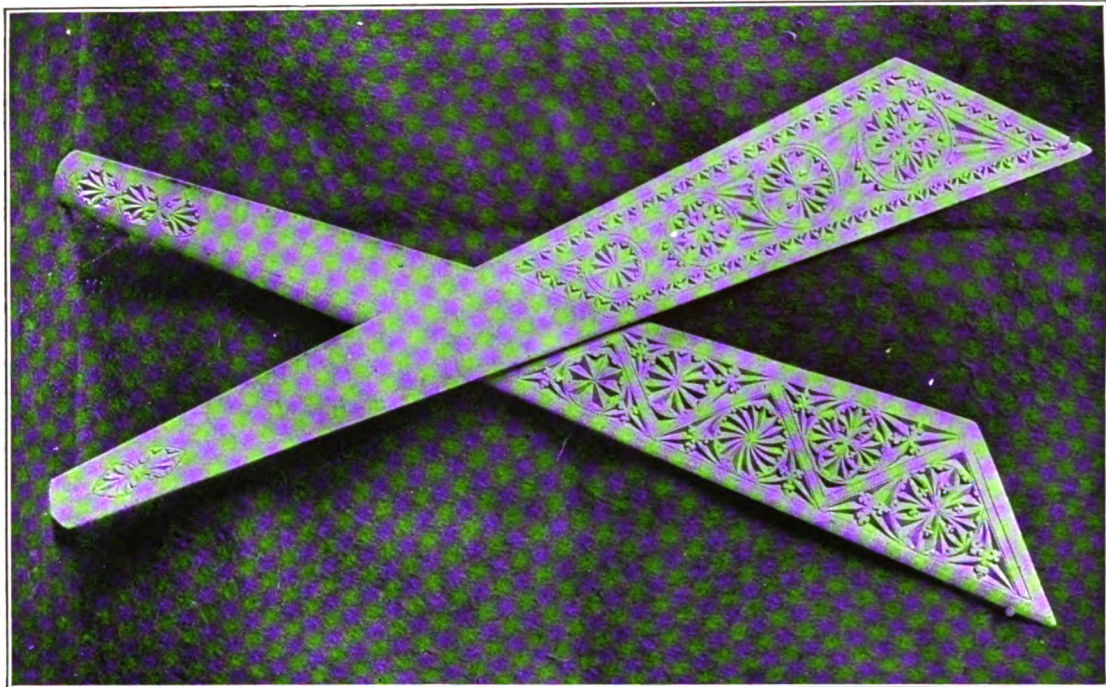

PLATE V

STAMP BOX. PLATE VI

The two blocks are to be fastened to the under side of the cover near the ends to keep the cover in position in case hinges are not used.



The puff box and the paper knives shown above were carved by Mrs. Edwin W. Foster of Brooklyn, N. Y. The box is made of pear wood. It was turned by a blind student in a school for the blind in Gothenberg, Sweden, and then carved by Mrs. Foster. The paper knives are made of apple wood. The blanks were made in Sweden but the carving was done in this country.

These carved objects represent a fine adaptation of the chip-carving forms that have been very common in the Northern countries of Europe.

STAMP BOX

TOP 48 x 18 x 3
 SIDE " x 5 x 8
 END 14 x " x "
 2 BLOCKS " x 2 x 8
 or the cover
 may be hinged.

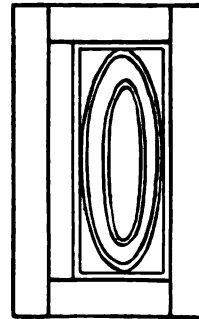
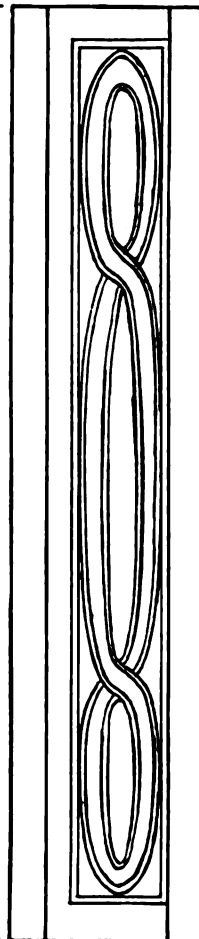
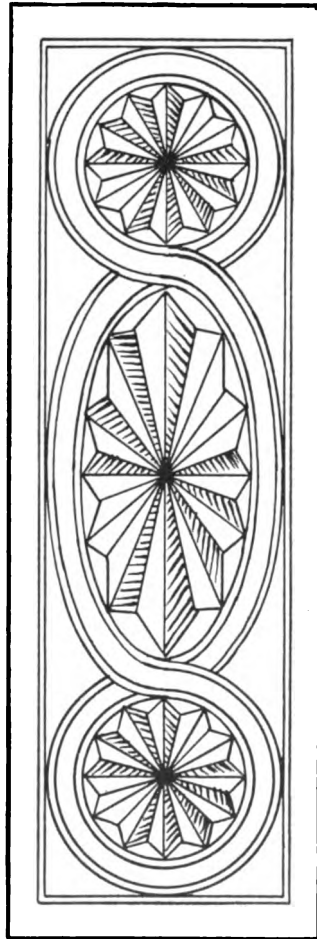

CARD CASE. PLATE VII

Of course, this case should be planned to fit the pack of cards used. The dimensions suggested fit some of the standard sizes. The catch depends upon springing the front and the back apart as the cover is pressed down. If carefully made, it holds the cover well.

CARD CASE

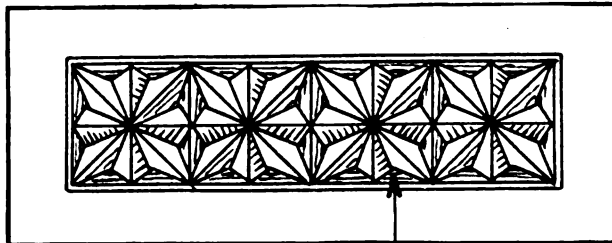

Deeper

A

TOP	$3\frac{3}{16}$	\times	$1\frac{1}{4}$	\times	$3\frac{3}{16}$
FRONT	$3\frac{7}{8}$	\times	$1\frac{5}{16}$	\times	"
SIDE	"	\times	$\frac{5}{8}$	\times	"
2 BLOKS	$\frac{5}{8}$	\times	$\frac{1}{2}$	\times	"
CATCH	$\frac{11}{16}$	\times	$\frac{2}{3}$	\times	$\frac{4}{4}$

Section at A
to show catch.

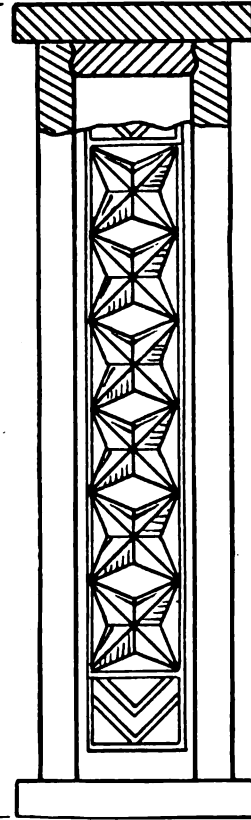
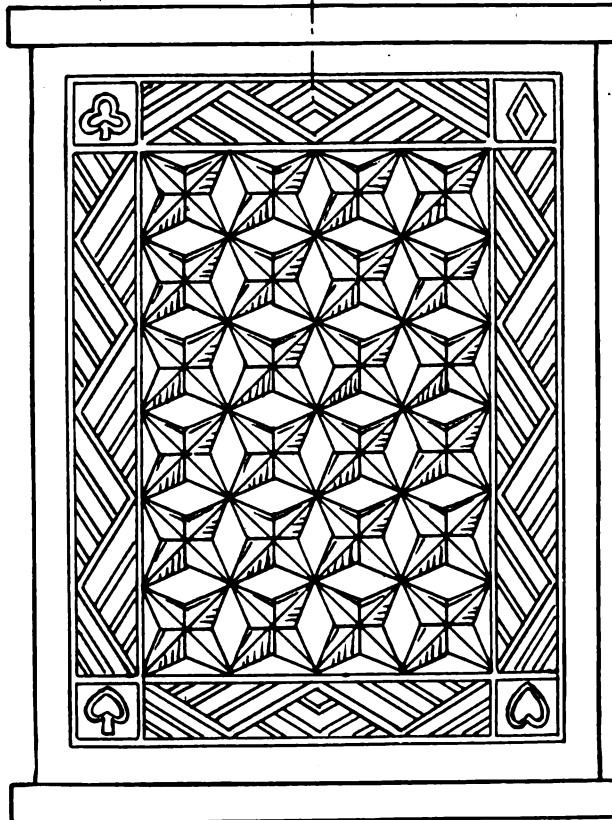

BLOTTER. PLATE VIII

It is desirable to use a $\frac{1}{8}$ chisel to stab the valley between the rows of diamonds. A brad awl might be sharpened for this purpose, or the knife will stab it in two operations.

BLOTTER

TOP $5\frac{1}{2} \times 3 \times \frac{1}{4}$
ROCKER $5\frac{1}{2} \times 3 \times \frac{7}{8}$

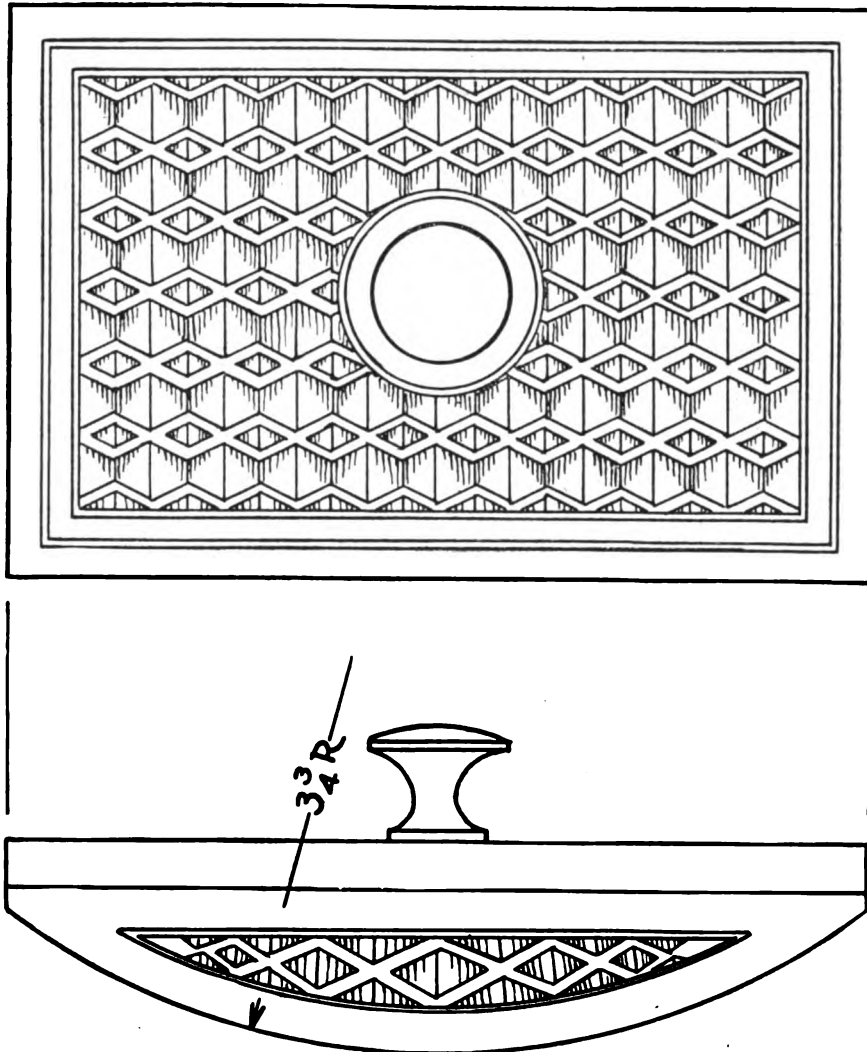

PLATE VIII

PEG MORREL. PLATE IX

Peg morrel (nine men's morris, shepherd's mill) is a fine game for two players. The moves are interesting, and victory or defeat may come quickly. The holes in this board are so placed that the game of fox and geese may be made on the reverse side of the board. The pegs should have ends so shaped and well sandpapered that they can readily be inserted into or removed from the holes. A skillful carver would carve the two inner borders on a layout consisting only of the rows of flat (uncut) triangles along their edges. Careful stabbing would finish the design.

DIRECTIONS FOR PLAYING*

First one player then the other places a peg in a hole, each striving to get a "mill" (three pegs in a row but not cornerwise) and also to prevent his opponent from getting a mill. A mill entitles its owner to remove one opponent's peg, but not from any mill he may have. After all pegs have been placed, they are moved, without jumping, along the lines, one hole at a move. When a player has only three pegs left, he can jump anywhere; when he has only two, he has lost the game.

**Manual Training Magazine*, Dec. 1918, page 134.

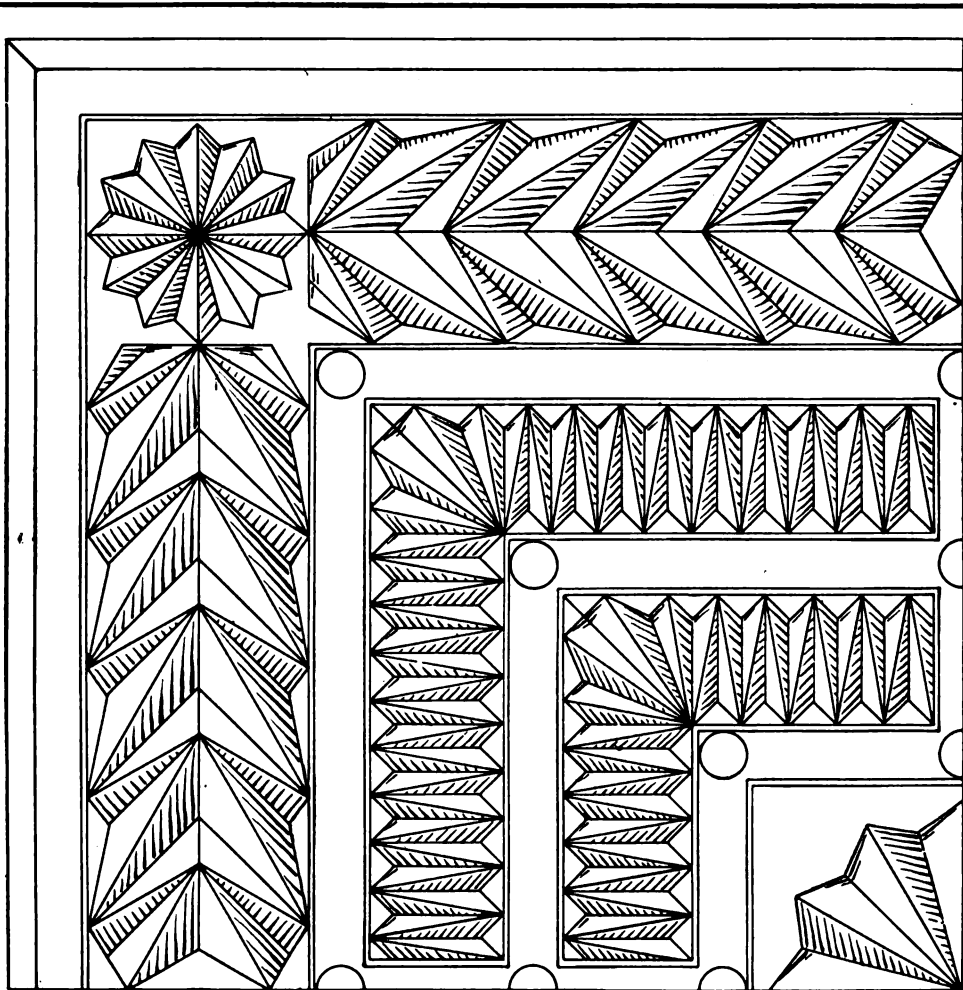

DEG
 MORREL
 NINE MEN'S
 MORRIS
 $10 \times 10 \times \frac{7}{8}$
 $\frac{1}{8}$ Chamfer →

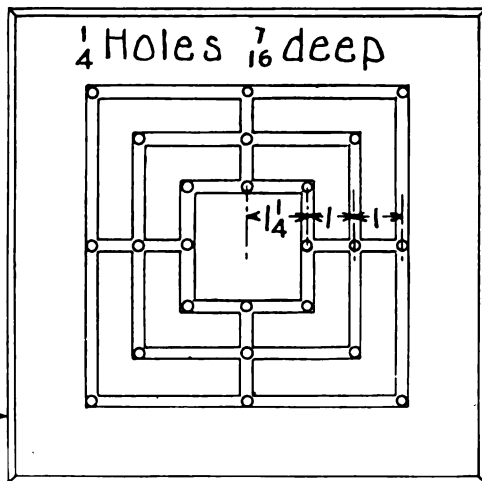

Make nine
 light & nine
 dark men
 of $\frac{1}{4}$ dowel
 $\frac{1}{4}$ long.

FOX AND GEESE. PLATE X

It often adds interest to a piece of decoration if its corresponding members are not exactly the same. This idea is carried out in Plate X and in Plate XV in the long chips along the sides of the board, the valley at the top of the plate being straight and the one at the left curved. Sparklets might be introduced in some of the diamonds.

DIRECTIONS FOR FOX AND GEESE

The fox is placed at the center hole. He can jump and so take up a goose next to him if the hole just beyond is empty. If conditions are right, he can sometimes jump more than one goose at a move. The fifteen geese occupy one arm (say the upper) of the cross solidly, and then extend to either side, occupying holes in the outer row.

For the geese to win, they must so block the fox that he cannot move.

DIRECTIONS FOR SOLITAIRE

The problems of solitaire are various: one, for example, being to start with all holes filled except the center one, then to jump (and take up) all pegs except the last one, which is to land in the center hole. One or several holes in other parts of the board may be left empty, and so other problems created.

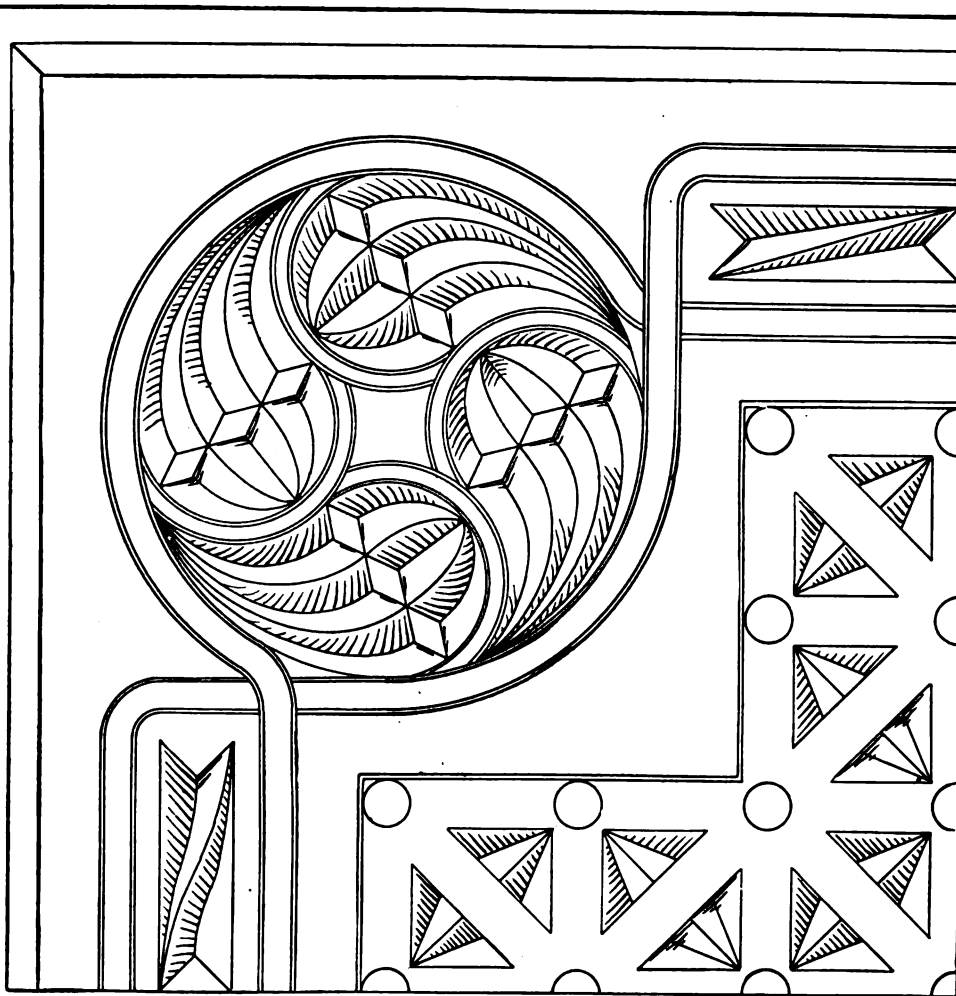

FOX AND GEESE

May be made
on reverse
side of $\circ\circ\circ$
PEG MORREL.

$\frac{1}{4}$ Holes $\frac{7}{16}$ deep 1 apart

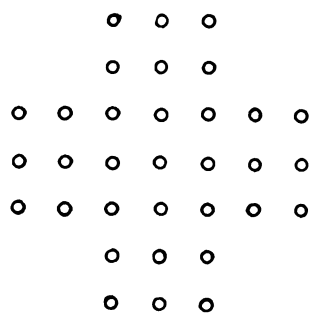

← $\frac{1}{8}$ + Chamfer

Make 15 geese
and 1 fox of
 $\frac{1}{4}$ dowel $1\frac{1}{4}$ long.
SOLITAIRE
may be played
with 32 pegs.

THERMOMETER MOUNTS. PLATE XI

These mounts are designed for thermometers measuring 4 x 1. They should, of course, be changed to fit other sizes which may be used. Because of the direction of the grain, care must be taken not to break the slender points of the flat surface in the border design of the shorter mount.

In the longer mount, other methods of cutting chips on this lay-out can be discovered. The inventive faculty thus employed is worth cultivating.

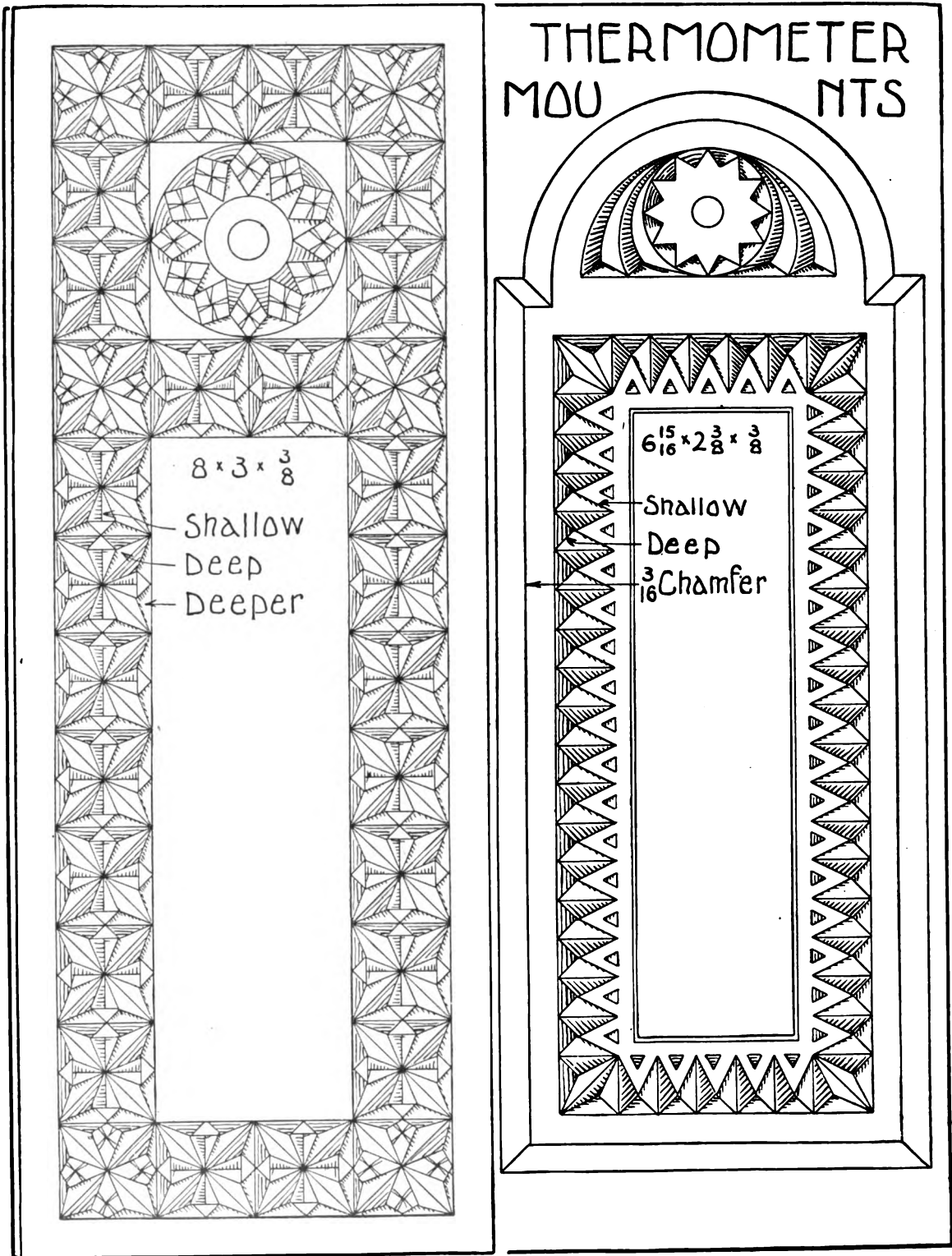

PLATE XI

PIPE RACK. PLATE XII

The holes in the shelf should be of suitable size to accommodate the pipes used. The upper edges of these holes should be well rounded and smooth. The long sweeping valleys in the back can be stabbed by drawing the knife point several times along these lines. To remove the chips smoothly will require several operations. The three small diamond-shaped surfaces at the left and right ends of the back piece are even with the main surface of the board and are simply stabbed on all four sides to receive the valleys.

HANDKERCHIEF BOX. PLATE XIII

The under top board should be screwed as well as glued to the cover, with the grain running cross-wise. The detail drawings show one-half of one side and one-half of the pattern for the cover.

PIPE RACK

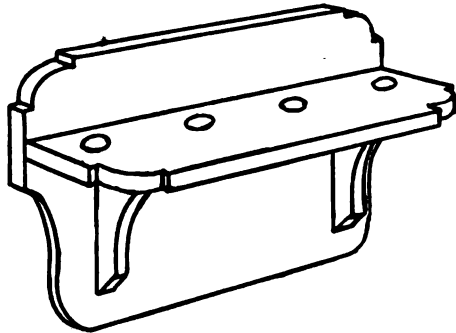

BACK $9 \times 7 \times \frac{1}{2}$
SHELF " $\times 3 \times$ "
BRACKET $4 \times 2 \times$ "

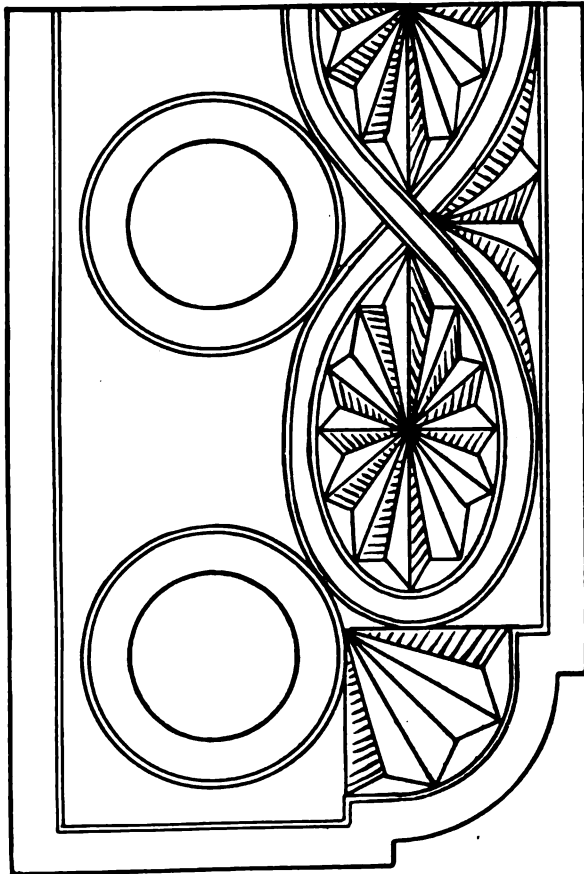

BACK OF PIPE RACK
9 × 7 × 1/2

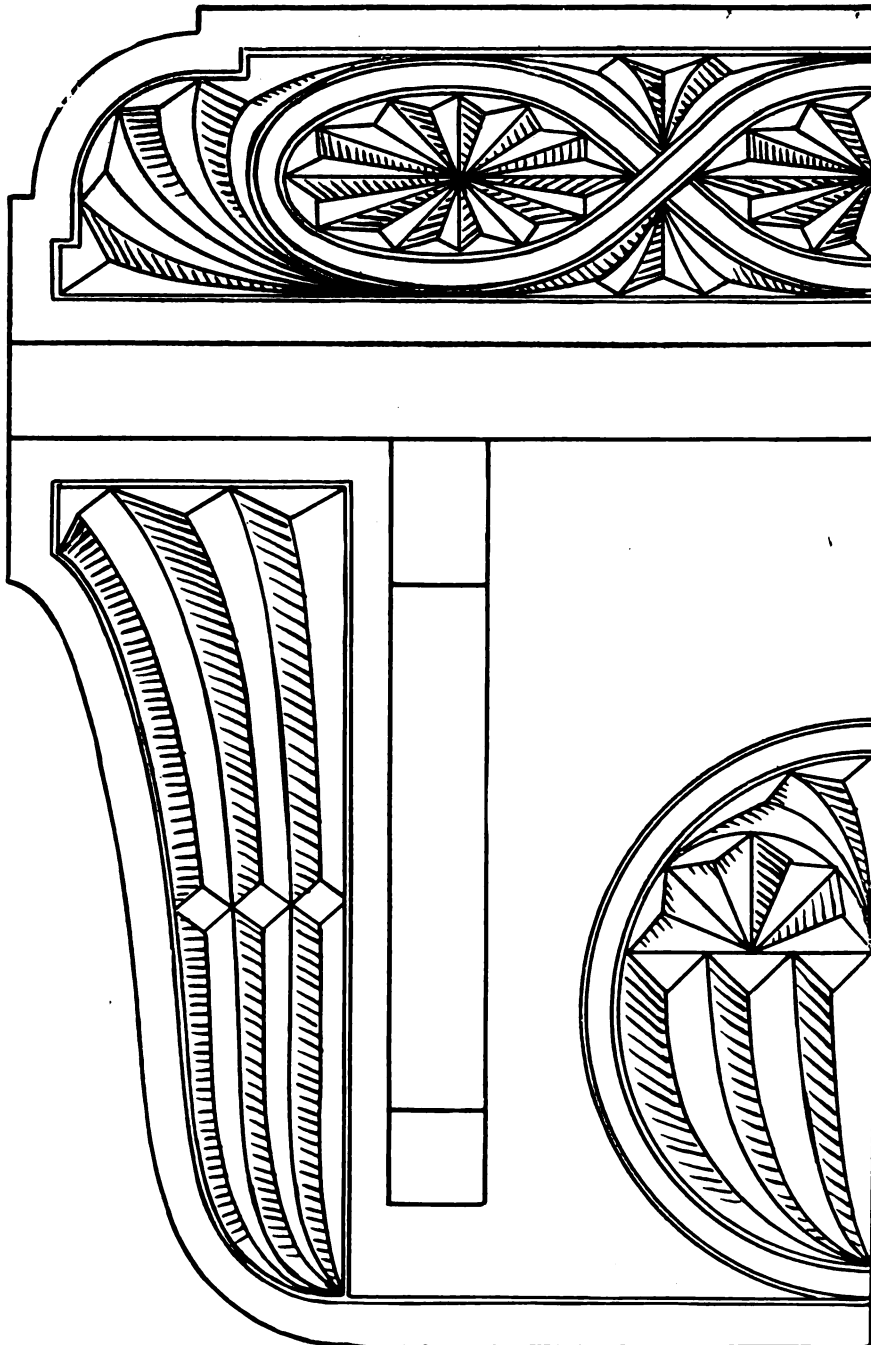
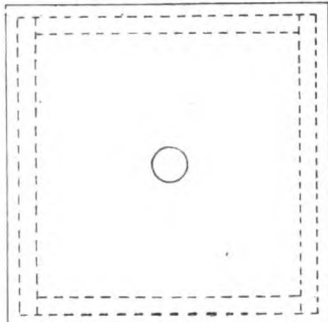
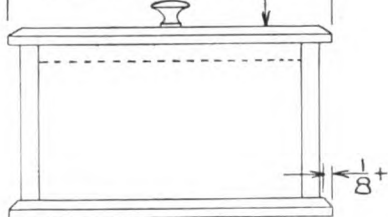

PLATE XII-A

HANDKERCHIEF BOX



Chamfer $\frac{5}{16} \times \frac{3}{16}$



TOP $6\frac{3}{4}$ sq. $\times \frac{3}{8}$

SIDE $6\frac{1}{4} \times 3\frac{1}{4} \times \frac{3}{8}$ END $5\frac{1}{2} \times 3\frac{1}{4} \times \frac{3}{8}$ UNDER TOP $5\frac{7}{16}$ sq. $\times \frac{3}{8}$

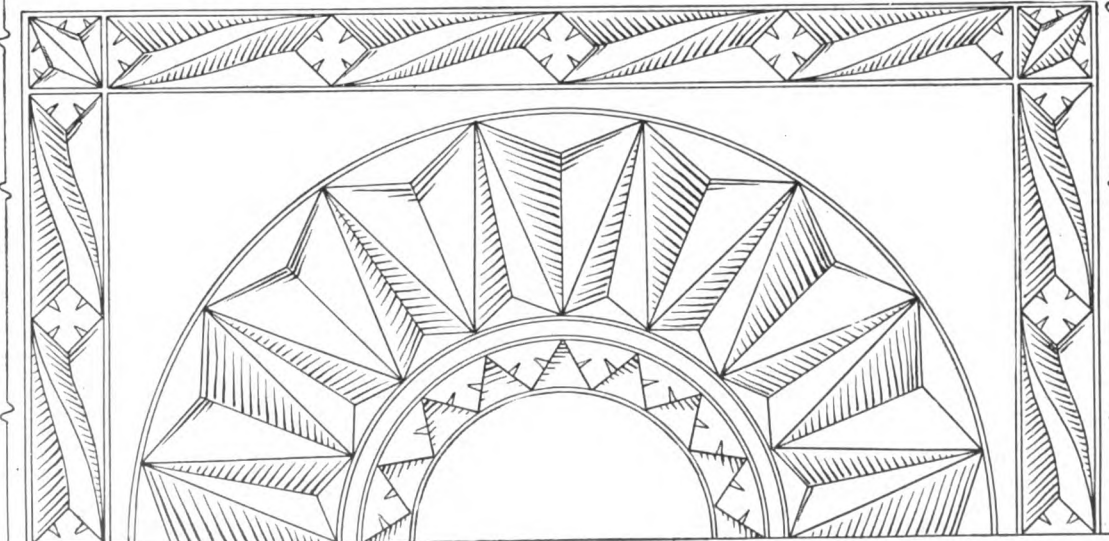
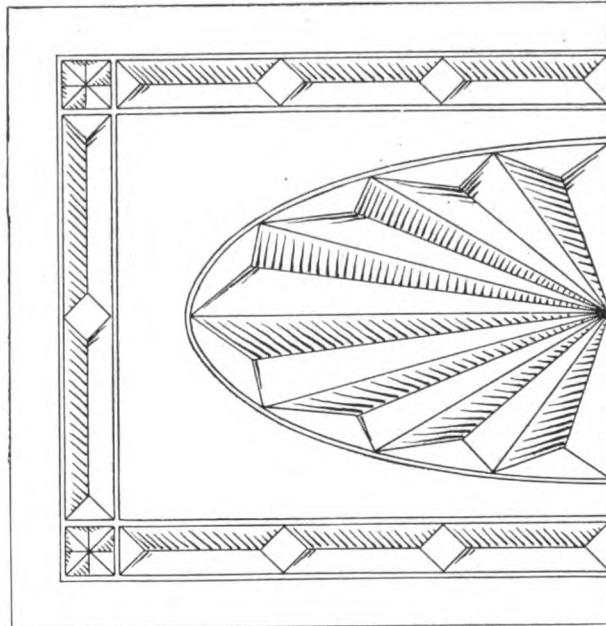

PLATE XIII

WHISKBROOM HOLDER. PLATE XIV

The front and the back of this model had better be carved before the parts are glued together. Because the design on the sides extends to its edges, the outside rows of chips are better cut after the parts are glued. The chips between the vertical rows of flat diamonds are somewhat peculiar in that their deepest points are not together, but are at opposite ends of the valley.

WHISKBROOM HOLDER

BACK

$$7\frac{3}{4} \times 4\frac{3}{4} \times \frac{1}{4}$$

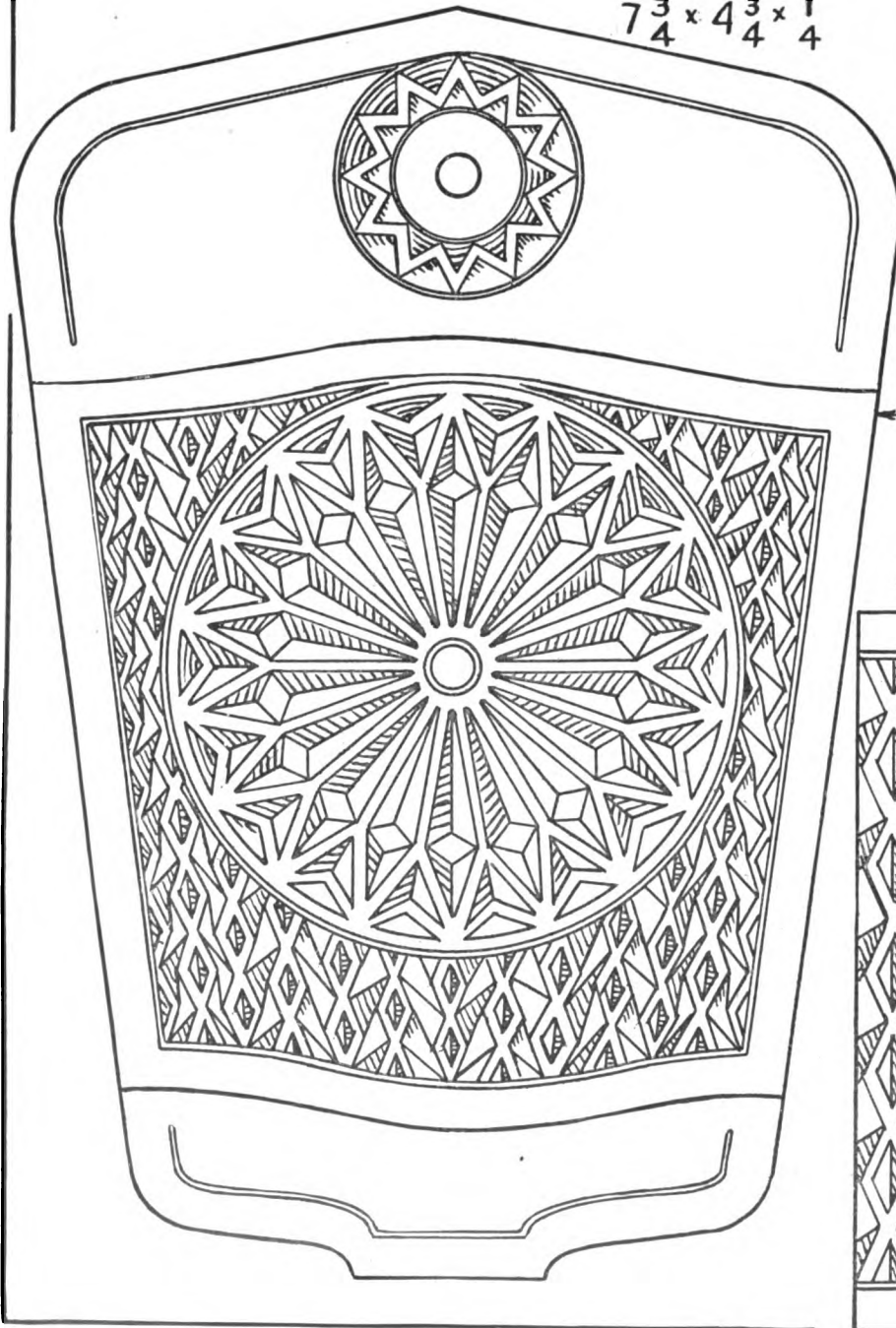
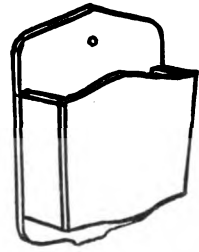

FRONT

$$4\frac{3}{16} \times 4\frac{1}{2} \times \frac{1}{4}$$

SIDE

$$3\frac{13}{16} \times 4\frac{1}{2} \times \frac{1}{4}$$

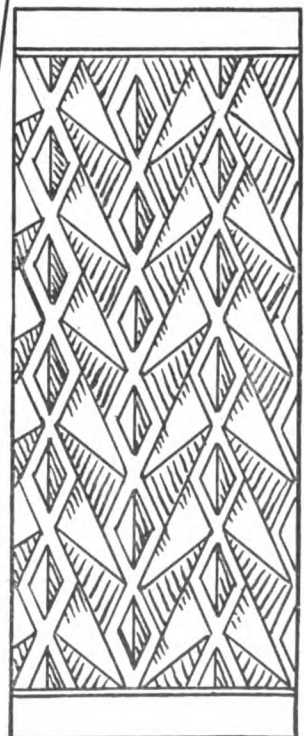

PLATE XIV

PICTURE FRAME. PLATE XV

The recess for the picture should be cut with chisel and router plane before the carving is executed. The circular opening can be cut with a large expansive bit or with a scroll saw. If the frame is to hang on the wall a small brass screw-eye may be used.

PICTURE FRAME

$6\frac{1}{2} \times 6\frac{1}{2} \times \frac{1}{2}$

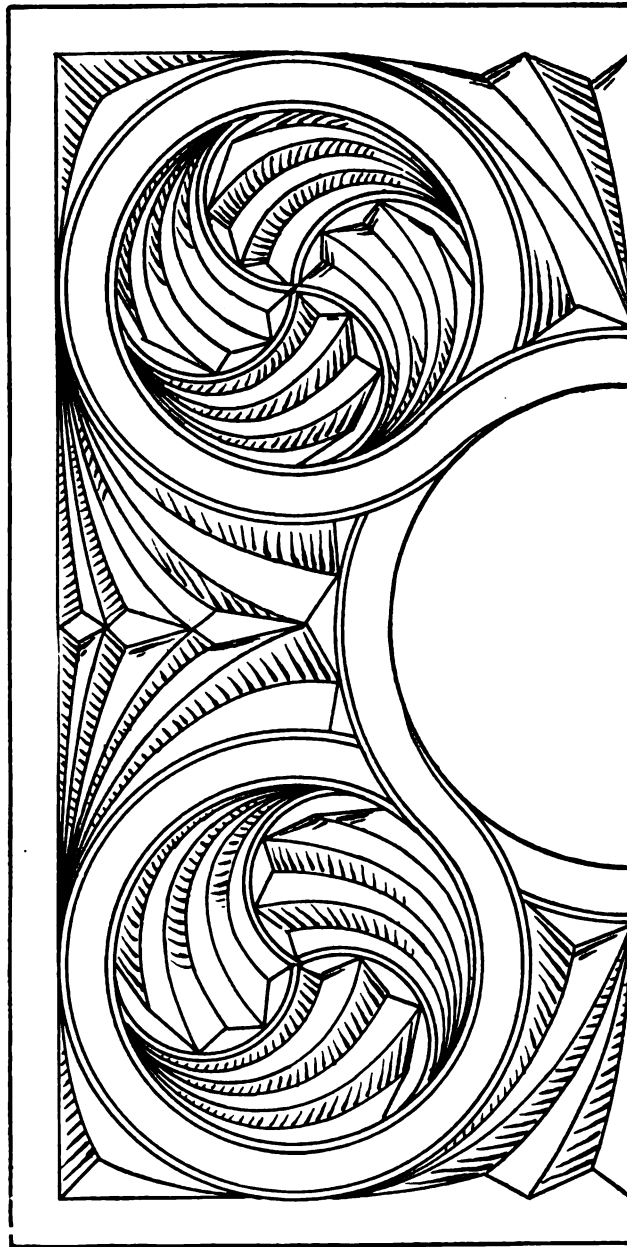

Cut a
square
recess
in back.

PHOTOGRAPH FRAME. PLATE XVI

The play of light and shade on this design when carved is much more interesting than the drawing suggests. The carving should be kept delicate, hence the flat radiating and elliptical bands must be made narrow. The narrower they are, however, the more liable to split are those which run across the grain. A pocket into which the photograph slips is built on the back. The brace presupposes the use of the frame as an easel.

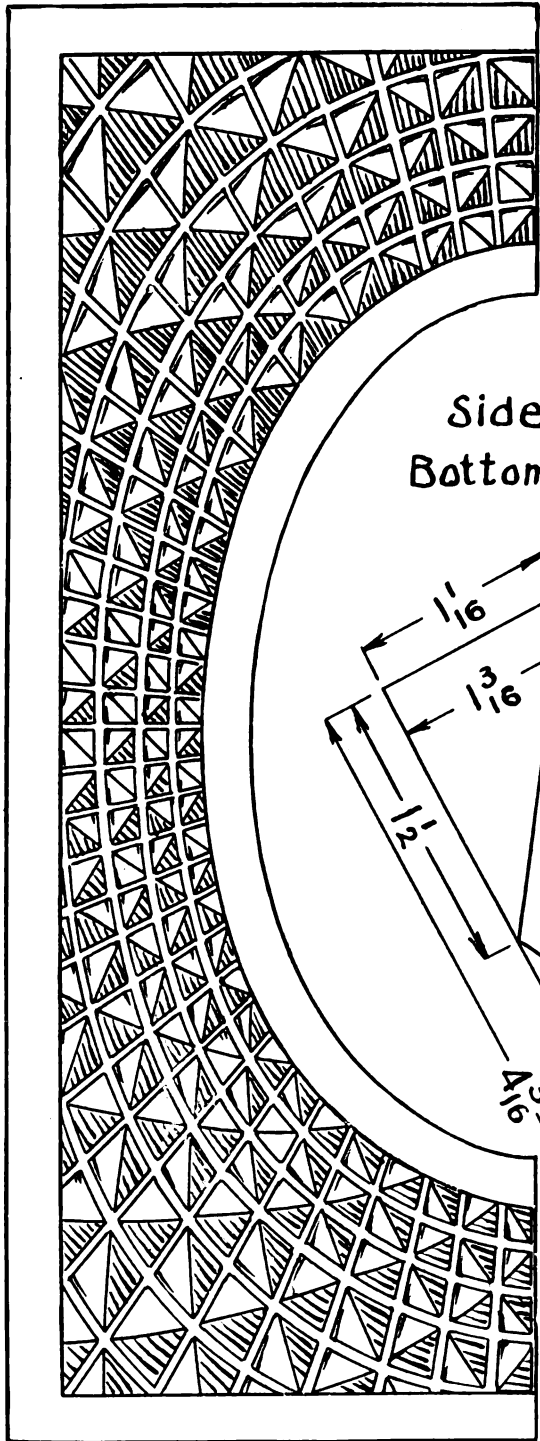

PHOTOGRAPH
FRAME

$7\frac{1}{2} \times 5\frac{1}{2} \times \frac{1}{4}$

Back $6\frac{3}{4} \times 4\frac{7}{8} \times \frac{3}{16}$

Side Cleats $6\frac{3}{8} \times \frac{3}{8} \times "$

Bottom Cleat $4\frac{7}{8} \times " \times "$

Brace $4\frac{3}{16} \times \frac{13}{16} \times "$

Top of Brace
is fastened
 $3\frac{7}{8}$
from
bottom of
Back.

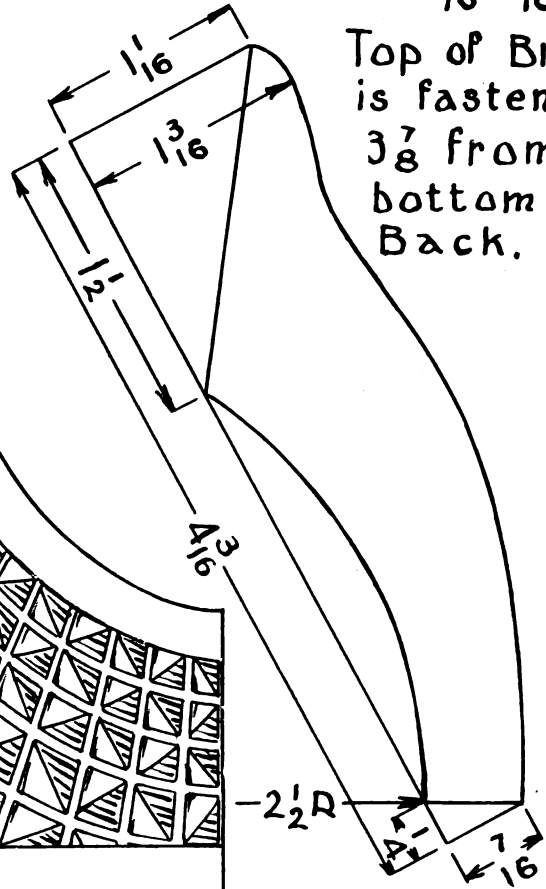

WHISKBROOM HOLDER. PLATE XVII

To stab these rosettes a gouge (Fig. 6) of suitable sweep is desirable, tho the curves can be cut by drawing the knife several times along them. Attention is called to the leaf pattern border on the edge and ends of the shelf. This border may, of course, be omitted. Accurate cutting of the sparklets will add much to the appearance of this article. The upper edges of the elliptical opening should be well rounded with sandpaper.

WASTE BASKET. PLATE XVIII

The octagonal bottom should be made as accurate as possible. The blocks between the eight vertical sides are best made in one long piece. They should be glued and nailed in place before the sides are screwed to the bottom. Only one screw should be put in each side until the tops are tied together. Two rosettes may give place to large brass ring handles. Finally, the sides should be laced together with raw-hide shoe or belt lacings.

WHISKBROOM HOLDER

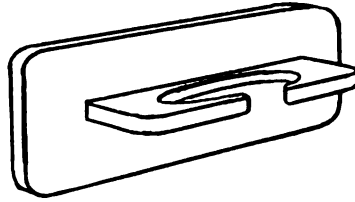
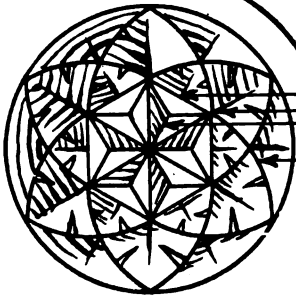

BACK
 $10\frac{3}{4} \times 3\frac{3}{4} \times \frac{1}{2}$

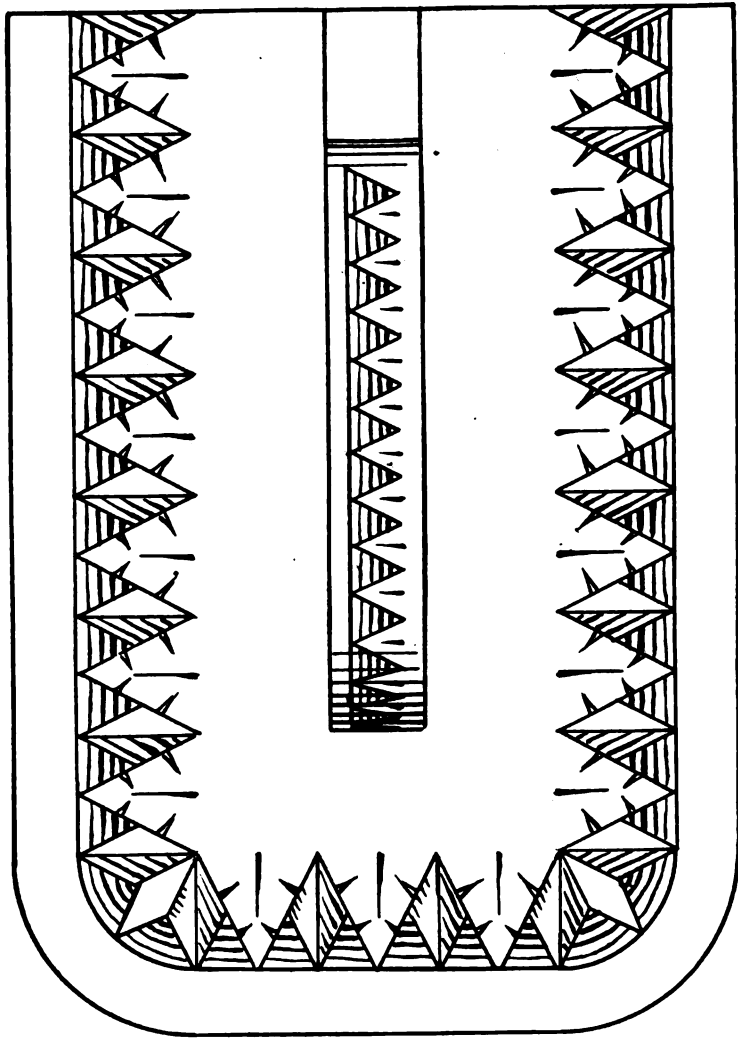
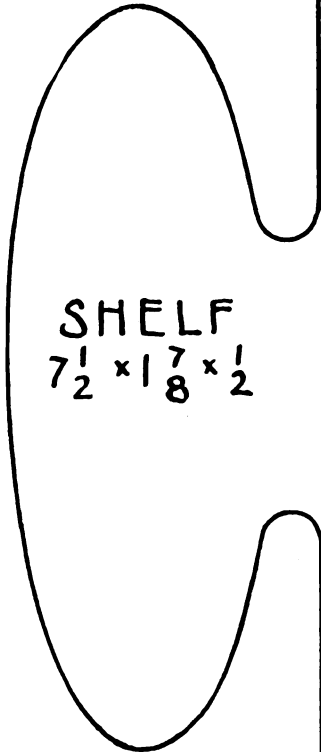

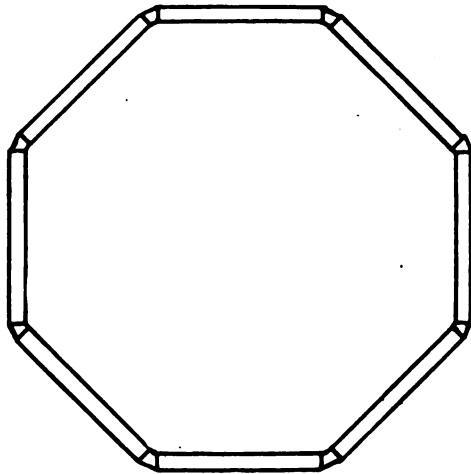

WASTE BASKET

BOTTOM $6 \times 6 \times \frac{3}{4}$
 8 SIDES $12 \times 2 \frac{3}{8} \times \frac{3}{8}$
 8 BLOCKS $1 \frac{1}{2} \times 7 \frac{7}{16} \times \frac{3}{8}$

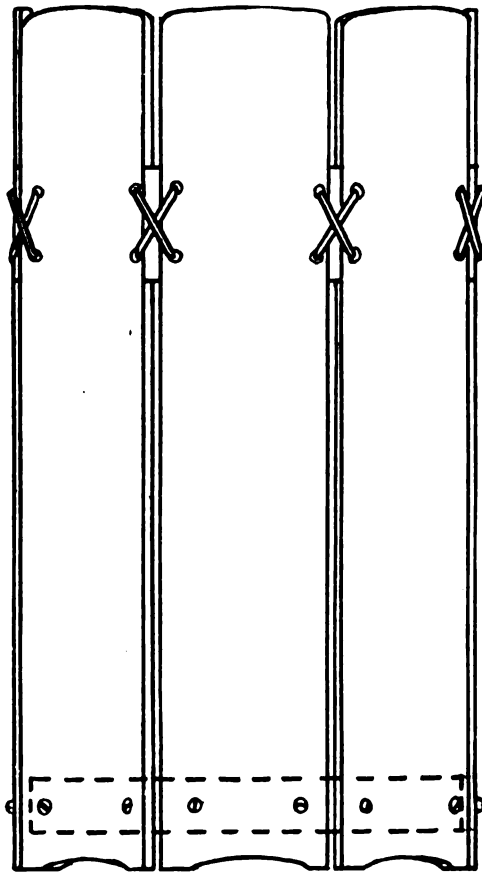

BLOCK Full Size

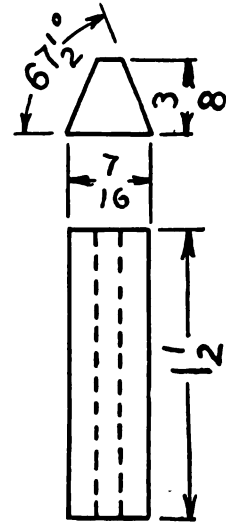

SIDE of WASTE BASKET

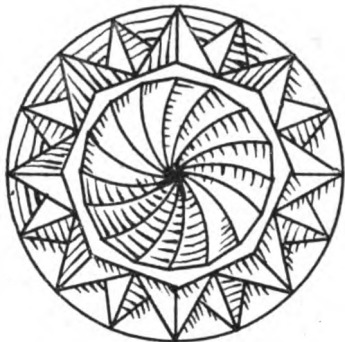
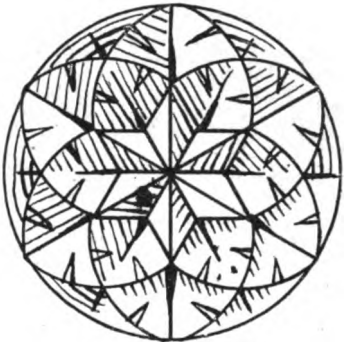

An easier rosette

AB Joins A'B'

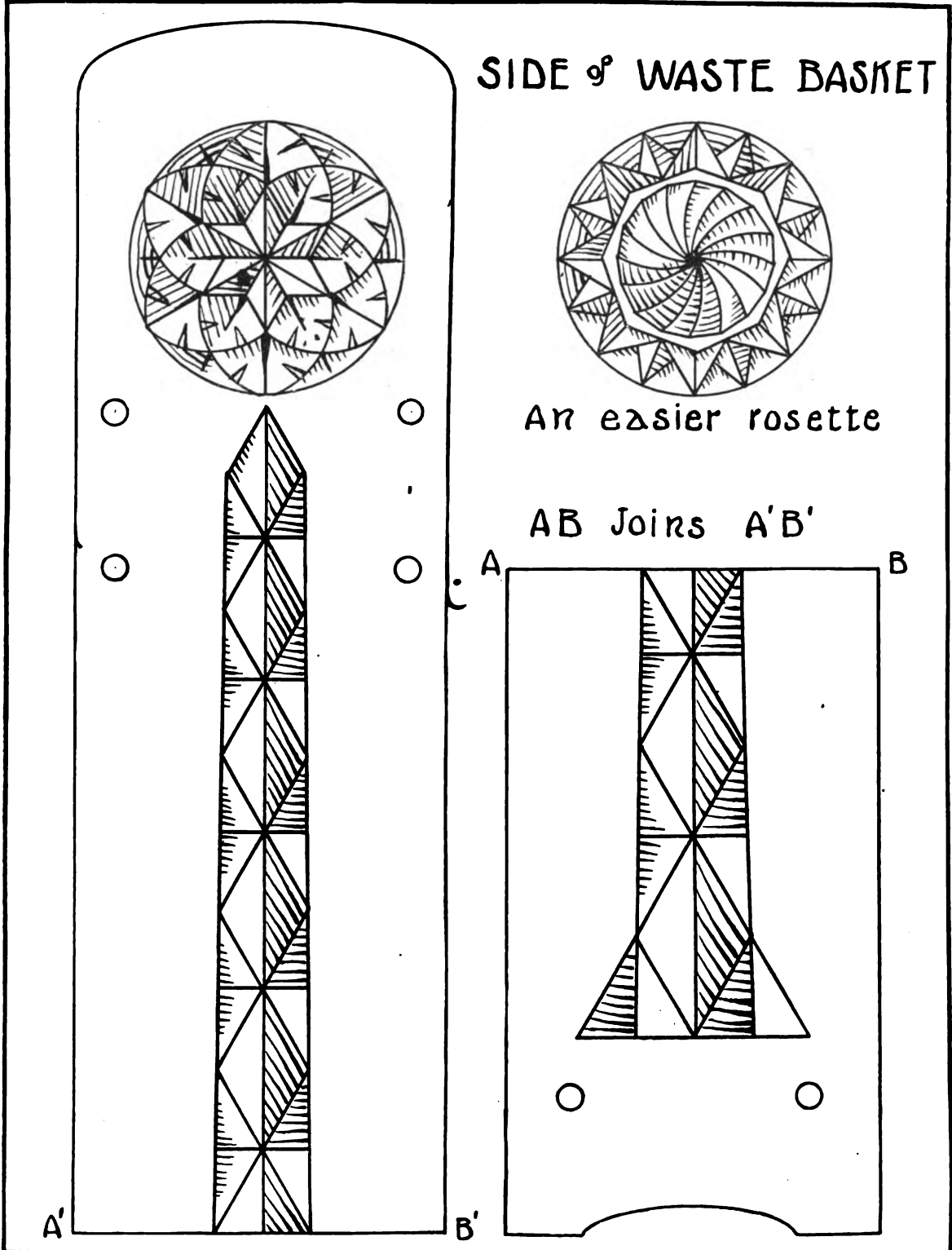

PLATE XVIII-A

PAPER KNIVES. PLATE XIX

These knives should be shaped completely before the carving is added. They should be made of firm, close-grain wood. The design of *B* was adapted from a paddle from the South Pacific islands; the design of *C* from a knife by Jenny Andréen in her book, *Chip-Carving Patterns*.

PAPER KNIVES

A $7 \times \frac{7}{8} \times \frac{3}{16}$

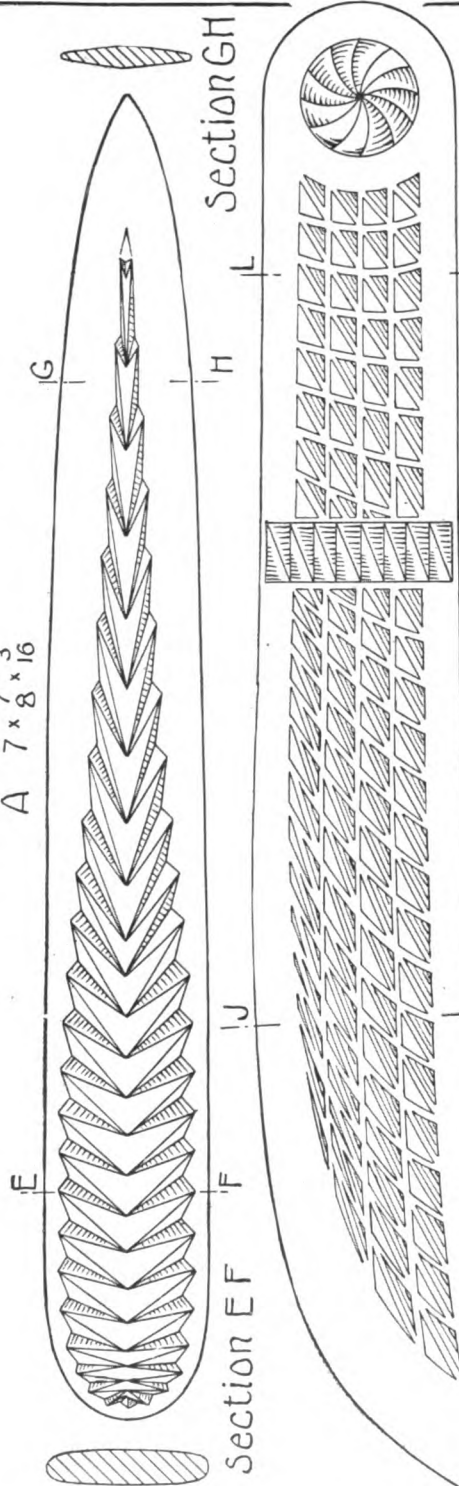

B $8 \times 1\frac{1}{2} \times \frac{1}{4}$

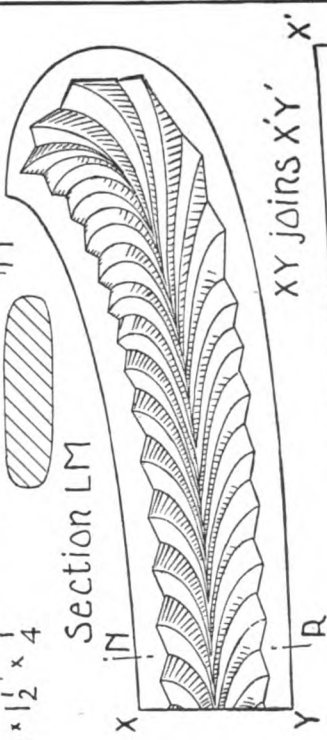

C $11 \times 1\frac{1}{8} \times \frac{1}{4}$

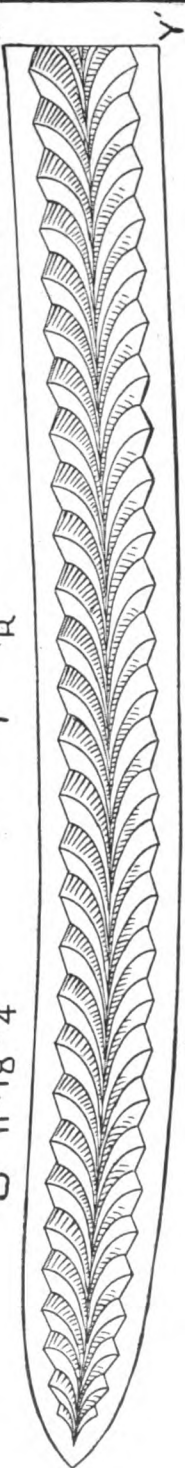

PLATE XIX

89057255754



b89057255754a

Date Due

OC 15 '65			

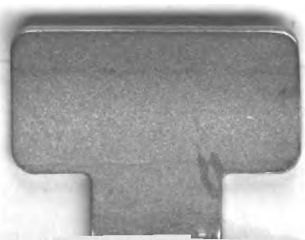

89057255754



b89057255754a